

Uniform Shipping Laws Code 2008

**Section 5J: Construction – Ferro-Cement
(CTH, NSW, QLD, SA, NT, TAS, VIC & WA)**

This is not the official version of the Uniform Shipping Laws Code.
The official version is that last published by the Australian Government Publishing Service,
Canberra, copies of which can be obtained from the National Marine Safety Committee.

SUB-SECTION J

Ferro-Cement

This Section is divided into Parts as follows:

- J.1 Application
- J.2 Definitions
- J.3 Plans and Specifications
- J.4 Special Requirements for Ferro-Cement Vessels
- J.5 Materials
- J.6 Mortar
- J.7 Construction of Hull
- J.8 Construction of Main Structural Members and Principal Built-In Components
- J.9 Placement of the Mortar
- J.10 Curing
- J.11 Construction Survey
- J.12 Painting and Other Surface Coatings
- J.13 Testing
- J.14 Equivalent Arrangements
- J.15 Special Considerations

1. Application

- 1.1 This Sub-section forms part of the Construction Section and shall be read in conjunction with its other Sub-sections.
- 1.2 The Construction Section shall be read in conjunction with the Introduction, Definitions and General Requirements Section.
- 1.3 These requirements shall apply to ferro-cement vessels built in Australia which are subject to the survey of an Authority.
- 1.4 A certificate of survey will not be issued for an existing ferro-cement hull unless proof is tendered that the hull was surveyed during construction by an acceptable Authority.

2. Definitions

- 2.1 *Ferro-cement* is a composite material consisting of a matrix made from hydraulic cement mortar and layers of wire or steel mesh reinforcement appropriately dispersed in the matrix with or without addition of steel rod reinforcement.
- 2.2 *Mortar* means a mixture of hydraulic cement, sand and water with or without the addition of additives.
- 2.3 *Mesh reinforcement* means the continuous fibres of wire or steel of specified configuration, size and dimensions which are appropriately dispersed in the matrix.
- 2.4 *Steel rod reinforcement* means an assembly of steel rod reinforcement which may or may not be present in the matrix.

3. Plans and Specifications

- 3.1 Specifications and/or plans showing the undernoted information are to be submitted and approved by the Authority before the construction of the vessel is commenced. These plans are to be drawn to a suitable scale i.e. 1/50 or 1/25 for drawings showing the full vessel and 1/10 for details and should indicate clearly the disposition and scantlings of reinforcement together with the thickness of the finished hull or structural component. Where a variation in thickness is required for local reinforcement this should be clearly indicated.
 - (a) Lines Plan
 - (b) General Arrangement which shows all deck openings, ventilators, masts, derricks, rigging, fuel, fresh water and ballast tanks, cargo spaces, fish holds, position of main propelling machinery, winches steering gear etc., in plan, section and elevation
 - (c) Longitudinal structural section in profile
 - (d) Midship section
 - (e) Bottom construction details including floors, keel, girders etc.
 - (f) Framing details
 - (g) Deck and local stiffening
 - (h) Shell
 - (i) Watertight bulkheads
 - (j) Stern frame and rudder
 - (k) Propeller brackets, shafting and bearings
 - (l) Main engine seatings
 - (m) Steering gear
 - (n) Superstructure and deckhouses
 - (o) Hatches and coamings
 - (p) Details of mast, derricks, rigging etc. with loadings anticipated under working conditions
 - (q) Such other plans, information and data as the Authority may consider necessary
 - (r) Details of special requirements for insulating holds, protection from heat sources and corrosion associated with fish juices and other corrosive substances.

- (s) A specification giving full details of the mortar mix, application method, proposed curing times and mortar-reinforcement ratio should be submitted for approval at the same time as the plans.

3.2 Prior approval of the Authority must be obtained before construction is commenced otherwise the vessel may not be accepted.

3.3 A scantlings table which sets out the recommended rod and mesh sizes has been included as Appendix A. Where the builders proposals for the scantlings differ greatly from those recommended, design calculations will require to be submitted for approval.

4. Special Requirements for Ferro-Cement Vessels

4.1 The construction of ferro-cement vessels is to be undertaken at premises which have been approved by the Authority.

4.2 The premises, facilities and equipment should be adequate to ensure that the vessel can be constructed to a standard which is acceptable to the Authority.

4.3 Adequate protection should be provided from the weather, in particular the sun, wind and extreme variations in temperature.

4.4 The premises should be staffed by competent persons and supervised by a management which is familiar with the techniques and materials used in the construction of ferro-cement vessels.

4.5 In cases where a team of experienced plasterers are employed on a part time basis the builder must assume full responsibility for their supervision and the work done.

5. Materials

5.1 General

All materials to be used must be of high quality, uniform and where applicable comply with the relevant Australian Standard. Substitution of materials shall not be undertaken without prior approval of the Authority.

5.2 Reinforcement

5.2.1 The reinforcing rods, bars and or wires shall be of steel complying with Australian Standards 1302, AS/NZS 4671 (Steel reinforcing materials), as may be applicable.

(Amendment dated 1 October 2008)

5.2.2 All reinforcing steel shall be cleaned of grease, loose rust, mud, oil, loose mill scale or any other coatings which would reduce its bonding qualities with the cement.

5.2.3 Longitudinal rods may be connected at the stem and stern by means of welding.

5.2.4 Except in the case of the wooden mould method each longitudinal rod, where welded at each end is to be fitted in two or more lengths which have a minimum overlap of 50 diameters or 300 mm in length whichever is the greater. All laps are to be staggered and secured with tying wire.

5.2.5 The steel rod reinforcement is to be accurately positioned to maintain alignment, and securely fastened by means of tying wire.

5.2.6 The longitudinal reinforcing rods are to be secured at each transverse rod by means of tying wire.

5.2.7 The tying wire to be used is 18 s.w.g. annealed soft iron wire.

5.2.8 Recommended sizes and the spacing of longitudinal, transverse and/or diagonal rods are set out in the table in Appendix A.

5.2.9 In cases where welding is necessary to secure the longitudinal, transverse and/or diagonal reinforcing rods special permission from the Authority is required.

5.2.10 The size of the mesh and number of layers required are given in the table in Appendix A.

5.2.11 The mesh should be secured:-

- (a) in vessels with longitudinal rods only at intervals not exceeding 100 mm; and
- (b) in all other vessels, at the intersection of all longitudinal and transverse or diagonal rods.

5.2.12 The minimum weight of steel reinforcement in any vessel shall be not less than 500 kg per cubic metre of mortar.

Section 5J (CTH, NSW, QLD, SA, NT, TAS, VIC & WA) 5

5.3 *Cement*

- 5.3.1 The cement used in the mortar is required to conform to the requirements set out in AS 3972 (Portland and blended cements), or ordinary or normal cement.

(Amendment dated 23 August 1996)

- 5.3.2 The cement should be fresh, have uniform consistency and be free of lumps or any foreign matter.
- 5.3.3 The cement should be stored under dry conditions for as short a period as possible. Cement over 4 months old is not to be used.
- 5.3.4 Batch certificates should be obtained from the supplier giving details of the cement e.g. age and quality. These certificates to be made available for inspection by the surveyor if required.
- 5.3.5 Other types of cement will be considered for use subject to the prior approval of the Authority.

5.4 *Sand*

- 5.4.1 The sand used in the mortar is to be clean and free from harmful materials and is to be of a sharp fine grade. There should be 10-15% fine sand and an even distribution of coarse sizes. The sand shall conform to the requirements of AS 2758.1 (Aggregates and rock for engineering purposes – Concrete aggregates), for fine aggregate and the sodium chloride content shall be not greater than 0.005 per cent.

(Amendment dated 1 October 2008)

- 5.4.2 The recommended gradings of the sand are given in a table in Appendix E.

5.5 *Additives*

- 5.5.1 Subject to the approval of the Authority additives may be used to improve the workability, adhesion, setting properties and anti-corrosive properties of the mortar. The chemical admixture containing chlorides or any salts of calcium or magnesium shall be used. Any other chemical admixture must conform to AS 1478.1 (Chemical admixtures for concrete, mortar and grout – Admixtures for concrete).

(Amendment dated 1 October 2008)

- 5.5.2 Pozzolans may be included as a replacement for up to 10% by weight of the cement. See also Appendix F item 1.
- 5.5.3 Chromium Trioxide may be added to the water to guard against galvanic corrosion. See also Appendix F item 2.

5.6 *Water*

- 5.6.1 The water used is to be fresh and free from any organic or harmful solutions which would adversely affect the properties of the mortar.
- 5.6.2 The use of ice water to retard evaporation and reduce the temperature of the mix in extreme conditions is desirable.

6. Mortar

- 6.1 The mix proportion shall be selected to obtain a reasonable compromise between high strength, low shrinkage and low permeability.
- 6.2 The mortar composition should consist of 800-1100 kg cement per cubic metre of sand.
- 6.3 The water to cement ratio should not be greater than 0.5 by mass and, for increased strength, a figure of 0.45 or less should be aimed at

$$\text{Water to Cement Ratio} = \frac{\text{mass of water used}}{\text{mass of cement used}}$$

- 6.4 In determining the water/cement ratio allowance should be made for the moisture content of the sand.

7. Construction of Hull

7.1 *General*

Any one of the following may be adopted for the construction of the hull.

- (a) Pipe frame method

- (b) Welded frame method
- (c) Wooden frame method
- (d) Frame and Batten method
- (e) Male or female mould method
- (f) Any other method approved by the Authority.

A description of these methods (a) to (e) is given in the Appendix G.

7.2 *Keel Steelwork, Bow and Stern Frames*

In methods (a), (b) and (c) above, the keel, bow and stern frames are the basic steel members to which the extreme ends of the longitudinal rods and the lower ends of the transverse rods are attached. They are to be of prefabricated bar and/or plate sections or castings which are effectively connected to one another by means of welding.

7.3 *Longitudinal and Transverse Rods*

The sizes, spacing, welding and tying of the longitudinal rods are to be in accordance with clause 5. The lower ends of the transverse rods must be welded to the keel steelwork.

7.4 *Mesh Reinforcement*

7.4.1 The sizes, number of layers and tying of the mesh are to be in accordance with paragraphs 5.2.10 and 5.2.11.

7.4.2 The mesh is to be evenly distributed on either side of the longitudinal and transverse reinforcing rods. The fine mesh should be kept to the outside at all times.

7.4.3 Square mesh should be applied with 30 mm overlaps on the seams. The joints should be effected by butting the wire together and securing with tie wires at 50 mm intervals, minimum. All butts are to be staggered by at distance at least equal to one frame space.

7.4.4 Every effort should be made in applying the mesh to keep it taut at all times and as compact as possible. If necessary additional tie wires should be used.

7.4.5 Square mesh should be used on the outside of the hull and the use of an alternative mesh is subject to the approval of the Authority.

7.4.6 A combination of an approved mesh and a square mesh may be used on the inside of the hull to facilitate attachment of floors, girders and frames.

7.5 *Attachment of Primary Structural Members to the Hull*

Provision is to be made to ensure an adequate connection between primary structural members and strict attention paid to the continuity of strength and avoidance of local stress build ups.

8. Construction of Main Structural Members and Principal Built-In Components

8.1 This will include the keel or centre girder, keelsons or side girders, transverse floors, transverse frames, transverse and longitudinal bulkheads, built-in tanks, decks, longitudinal deck girders, hatch coamings, pillars, engine bearers, transom stern, stern tube and rudder supports.

8.1.1 The steel reinforcement provided for main structural members and principal built in components must have minimum steel mass content of not less than 5 kg per square metre per centimetre thickness of mortar.

8.2 *Keel and Centre Girder*

8.2.1 Depending on the type of vessel the keel may be either a centre girder or bar keel type.

8.2.2 If constructed as a centre girder the following apply:

- (a) The basic structural member is to be a steel bar or tube with dimensions in accordance with Appendix H.
- (b) The upper portion of the bar or tube is to provide a means of attaching the vertical keel steel reinforcement rods. The hull reinforcement rods are to be attached to the underside or lower portion of the bar - see Appendix I.
- (c) The depth and minimum thickness of the keel is to be the same as that of the transverse floors - see Appendix K.

- (d) The centre girder must be fitted as a continuous structural member except in vessels under 16 metres in length where the Authority may permit the provision of intercostal centre girders
 - (e) Where tubes are used protection against internal corrosion is to be provided.
- 8.2.3 If constructed as a bar keel the following apply:
- (a) The bar keel is to be fitted as a continuous structural member.
 - (b) The dimensions of the keel are to be in accordance with Appendix J.
- 8.2.4 A typical bar keel arrangement is shown in Appendix J.
- 8.3 *Stem Bar and Stern Frame*
- 8.3.1 The basic structural member of the stem bar or stern frame is to be a steel bar or steel tube with dimensions in accordance with Appendix H.
- 8.3.2 The ends of the hull reinforcement rods may be welded direct to this bar.
- 8.3.3 The Authority may require breasthooks to be fitted at 1 metre intervals to stiffen the stem. The thickness of the breasthooks is to be similar to that of the floors - see Appendix K.
- 8.3.4 The stern frame arrangements must be adequate for the attachment of the hull longitudinal reinforcement rods, stern tube, rudder skeg or sole piece. The scantlings of the sole pieces are given in Appendix AC.
- 8.4 *Keelsons or Side Girders*
- 8.4.1 If the breadth of the floor at rule height is 5 metres or more, keelson or longitudinal side girders are to be fitted intercostally between the floors.
- 8.4.2 These girders are to be the same depth as the floor, at the same position off the centreline, and to have thicknesses in accordance with Appendix K.
- 8.4.3 The vertical steel reinforcement rods are to overlap the hull transverse rods alternately inboard and outboard over a length of 600 mm. Tie wires are to be spaced 100 mm apart. See typical sketch-Appendix M.
- 8.5 *Transverse Floors*
- 8.5.1 Solid floors are to be fitted at every frame.
- 8.5.2 Floors are to be continuous from side to side except where a continuous centre girder (or keel) is required to be fitted or special stiffening arrangements are required for engine bearers.
- 8.5.3 The depth and thickness of transverse floors are set out in Appendix K.
- 8.5.4 The connection between the frames and floors is to be continuous and the frame depth at this connection is to be increased in accordance with the sketch shown as Appendix N.
- 8.5.5 The hull attachment for the floors is to be provided by means of starter rods which are to be fitted in accordance with the sketch-see Appendix O.
- 8.6 *Transverse Frames*
- 8.6.1 The spacing and frame section moduli are set out in Appendix P.
- 8.6.2 The minimum frame depth is not to be less than that recommended in Appendix P.
- 8.6.3 The frame depth is to be increased in way of the frame/floor connection - see sketch, Appendix N.
- 8.6.4 The frame depth is to be increased in way of the frame/deck beam connection - see sketch, Appendix Q.
- 8.6.5 The shell attachment for the frames is to be provided by means of starter rods fitted in accordance with the sketch-see Appendix R.
- 8.6.6 Special consideration will be required in cases where web or deep frames are introduced into the hull structure.
- 8.7 *Transverse and Longitudinal Watertight and Non-Watertight Bulkheads*
- 8.7.1. The thicknesses of watertight bulkheads and stiffener sizes are set out in Appendix S.

- 8.7.2 The shell attachment for the bulkheads is to be provided by means of starter rods which are fitted in accordance with the sketch-Appendix R.
- 8.7.3 Within the bulkhead, the distribution of the steel reinforcing rods in the vertical and transverse directions is to be equal.
- 8.7.4 The reinforcing rods for the bulkhead stiffeners may be welded direct to the bulkhead reinforcing rods or attached by means of starter rods - see sketch, Appendix R.
- 8.7.5 In cases where the bulkhead is attached by means of a shell ground frame, approval of the method adopted must be obtained from the Authority.
- 8.7.6 The shell attachment for longitudinal bulkheads is to be provided by means of starter rods which are tied to the shell transverse reinforcing rods.
- 8.7.7 The bulkhead thicknesses and stiffener sizes set out in Appendix S apply equally to non-watertight bulkheads.
- 8.8 *Built-In Tanks*
- 8.8.1 Tanks may be 'built-in' to the vessel's structure provided they are to be used exclusively for the carriage of fresh water or ballast water only.
- 8.8.2 Tanks constructed of ferro-cement regardless of their internal protective coatings are not to be used for the carriage of diesel fuel.
- 8.8.3 The construction of the tank is to be such that it can withstand the liquid pressures it would be subjected to in the course of normal usage. This applies especially to the crown of the tank and its hull attachments.
- 8.8.4 A means is to be provided for easily gaining access to the tank for cleaning and inspection purposes. The cover and means of securing any openings will be the subject of special consideration by the Authority.
- 8.8.5 Adequate filling, emptying and venting arrangements are to be provided.
- 8.9 *Decks*
- 8.9.1 The thickness of the deck and section moduli for deck beams are set out in Appendix T.
- 8.9.2 A deck girder will require to be fitted so as to limit the maximum span of any deck beam to 3.5 metres.
- 8.9.3 The means of attaching the beams to the deck longitudinal reinforcing rods may either be by welded or tied starter rods-see sketch, Appendix R.
- 8.9.4 The beam depth is to be increased in way of the beam/frame connection see sketch, Appendix Q.
- 8.9.5 Continuity of strength is to be maintained at the deck/shell connection see sketch, Appendix U.
- 8.9.6 Provision is to be made for maintaining the deck strength in way of hatches or other openings.
- 8.10 *Longitudinal Deck Girder*
- 8.10.1 Longitudinal deck girders are to be fitted in vessels over 16 metres in length to impart longitudinal strength in the structure.
- 8.10.2 A deck girder will require to be fitted in any vessel so that the span of any deck beam is not in excess of 3.5 metres.
- 8.10.3 A deck girder will require to have intermediate support so as to limit the length of any span to 3.5 metres or the tabular modulus of the girder to $9.85 \times 10^5 \text{ mm}^3$.
- 8.10.4 The section moduli for longitudinal girders are set out in Appendix V.
- 8.11 *Hatch Coamings*
- 8.11.1 The height of hatch coamings is to be in accordance with the requirements of the Authority.
- 8.11.2 The covers or closing appliances for a hatch are to be of adequate strength and in accordance with the requirements of the Authority.
- 8.11.3 Hatch coamings are to be constructed with the same sized reinforcing rods and mesh as the decks.
- 8.11.4 Provision is to be made for maintaining the strength of the deck in way of hatch openings.

- 8.11.5 Fore and aft cargo hatch coamings are to be integrated with longitudinal deck girders and, if necessary, provided with intermediate underdeck support by means of pillars, bulkheads or deep frames.
- 8.11.6 Provision is to be made on the underside of the deck for supporting transverse cargo hatch coamings.
- 8.11.7 Cargo hatch side and end coamings are to be provided if necessary with horizontal stiffeners and vertical brackets.
- 8.11.8 Cargo hatch side coamings are to be provided, if necessary, with additional steel reinforcement, so as to increase their resistance to impact damage.

8.12 *Pillars*

- 8.12.1 Where necessary tubular steel or other suitable pillars are to be provided as intermediate supports for longitudinal deck girders and hatch end supports.
- 8.12.2 Pillars may be used as deck supports for concentrated loads which cannot be taken by bulkheads or other substantial vertical structural members.
- 8.12.3 Adequate provision is to be made for absorbing and distributing the load occurring at the head and heel, respectively of a pillar.

8.13 *Engine Bearers*

- 8.13.1 Engine bearers are to be integrated with both the transverse floors and bottom longitudinal girder systems in the engine room.
- 8.13.2 The engine bearer steel reinforcement rods are to be integrated with the shell reinforcement and extended as far as possible in both the transverse and longitudinal directions.
- 8.13.3 If necessary, additional steel reinforcing rods should be included in the framework of the engine bearers.

8.14 *Transom Stern*

- 8.14.1 The scantlings for the transom stern are to be taken from scantlings table - Appendix A.
- 8.14.2 The sizes of the transom stiffeners are to be obtained from the frame table - Appendix P.
- 8.14.3 The transom stiffeners are to be integrated with the keel/stern frame arrangement and longitudinal side girders in the vicinity of the transom.

8.15 *Stern Tube*

- 8.15.1 The stern tube may be fitted as an integral part of the stern framework, attached to the steel tubes, bars, sections or castings which make up the stern frame unit.
- 8.15.2 The following minimum thicknesses are recommended as being appropriate for steel stern tubes:

<i>Length of Vessel</i>	<i>Thickness</i>
10-15 metres	7.5 mm
15-25 metres	9.5 mm
25-30 metres	13.5 mm

8.16 *Rudder Supports*

- 8.16.1 The pedestal in the steering gear space is to be provided with adequate support in the fore and aft and a wartship directions.
- 8.16.2 In cases where no rudder post is fitted the rudder bottom bearing is to be welded to a skeg or sole piece. The sectional area of the skeg or sole piece shall be in accordance with the table in Appendix AC.

9. Placement of the Mortar

9.1 *General*

Prior to the plastering process all mesh and steelwork must be completed. The hull is to be inspected by the surveyor and any loose mesh ends or rods secured with tie wire. Any dirt or loose pieces of material must be removed with special attention being paid to the recesses such as the keel and the ends during the process.

9.2 *Attendance of Surveyor*

The Authority is to be advised in good time so that a surveyor can be in attendance during the plastering process.

9.3 *Supervision of Labour*

In cases where a team of plasterers and labourers are employed on a part time basis, for the placement of the mortar, the builder must assume full responsibility for their supervision and the work done.

9.4 *Builder's Responsibility*

The builder must assume full responsibility for ensuring that the

- (a) labour,
 - (b) materials including water,
 - (c) equipment for mixing the mortar,
 - (d) equipment for handling the mortar from the mixing to the placement positions,
 - (e) staging both within and outside the hull, and
 - (f) artificial lighting (in case work proceeded during the hours of darkness)
 - (g) curing equipment and materials
- are adequate.

9.5 *Mixing of the Mortar*

9.5.1 The mortar is to be mixed in a motorised mixer, preferably of the paddle type.

9.5.2 To ensure uniformity of the mortar mix throughout the plastering operation it is essential that strict control is exercised during the mixing process so that the correct quantities of sand, cement, additives and water are added to each batch. The quantities are to be measured not estimated. Details of measuring methods are contained in Appendix W.

9.5.3 The mixing of the mortar is to be a continuous process. Once the mortar has been thoroughly mixed it should be used as quickly as possible. Continued mixing of the mortar is not permitted.

9.6 *Placement of the Mortar*

9.6.1 Where it is not possible to plaster a whole vessel in one operation the placement process should be divided into a number of stages basically as follows:

- (a) Hull and frames,
- (b) Keelson, side girders and floors,
- (c) Bulkheads, deck beams and deck girders,
- (d) Decks and coamings.

9.6.2 The placement of the mortar for each stage should be carried out in one continuous operation.

9.6.3 Plastering in layers is not acceptable.

9.6.4 The mortar may with the approval of the Authority be forced through the mesh from one side only by means of a surface vibrator.

9.6.5 Any other method of mortar placement other than by hand application must be submitted to the Authority for prior approval.

9.6.6 When complete penetration has been achieved the opposite side is to be trowelled so that the mortar is evenly distributed over the surface of the mesh.

9.6.7 If necessary both sides should be trowelled to work out any mortar displacements occurring when the opposite side is worked.

9.6.8 Every effort should be made during the placement and trowelling operations to ensure that voids are eliminated and the mortar is evenly compacted.

9.6.9 Special attention should be given to the penetration and compaction of the mortar in places where the accessibility for plastering is difficult or there is a congestion of reinforcement mesh.

- 9.6.10 The mortar placement process should not be carried out;
- (a) in direct sunlight,
 - (b) unless protected from a drying wind, and
 - (c) when the temperature in the premises is less than 5°C or greater than 27°C unless special permission is received from the Authority.
- 9.6.11 In cases where the steel reinforcement is attached to a mould the surveyor must be satisfied that complete mortar penetration is being achieved.
- 9.7 *Connections Between Existing Work and New Work*
- 9.7.1 Existing work should be allowed to cure for at least 7 days before any new work is attached where displacement of previously placed mortar is likely to occur.
- 9.7.2 Joining edges are to be cleared of any powdered cement laitence, cement droppings or pieces of dirt and a cement grout, or an approved jointing compound is to be used strictly in accordance with the manufacturer's instructions.
- 9.8 *Surface Finish*
- 9.8.1 The reinforcement is to be covered on exposed faces by a layer of mortar having a thickness of between 1.5 mm and 3 mm.
- 9.8.2 All loose ends of the mesh or tie wires which become apparent after the curing process has taken place, are to be cut back and the surface made good with epoxy cement fillers.
- 9.8.3 Any unevenness or roughness of the hull may be smoothed down by use of a carborundum stone.

10. Curing

10.1 *General*

The curing process is most important as the strength of the mortar is dependent upon it. There are two basic methods of curing which are acceptable to the Authority:

Wet cure

Steam cure

Both methods are described in detail in Appendix X.

10.2 *Method to be used*

The builder must submit a proposal to the Authority giving full details of the curing method to be adopted and the means by which the temperature is controlled.

10.3 *Curing Process*

- 10.3.1 The curing process should be commenced not earlier than 4 ½ hours nor later than 12 ½ hours following the final placement of the mortar.
- 10.3.2 The time/temperature curing conditions are to comply with the published recommendations of the cement manufacturer. Any proposal to depart from these recommendations must be submitted in writing to the Authority. An accompanying statement affirming the cement manufacturer's agreement must be attached to this proposal if considered necessary. Details of the effects of time and temperature on curing are contained in Appendix Y.
- 10.3.3 Subject to the provisions of paragraph 9.7.1 no loads are to be applied to the hull until
- (i) 4 days after commencement of the wet cure
 - (ii) 2 days after commencement of the steam cure.
- These periods also apply to persons walking about or working on the vessel.
- 10.3.4 Subject to the provisions of paragraph 9.7.1 no new stages are to be commenced until after the first or previous stage has cured for a period of seven days. The plastering of the now stage is to be completed as soon as possible so, that the curing process can be continued.
- 10.3.5 All test pieces are to be cured in a similar manner and at the same time as the hull or other stage.
- 10.3.6 The curing operation is to be commenced in the presence of the surveyor and the arrangements made must be to his satisfaction.

10.3.7 Chemical curing materials should not be used.

11. Construction Survey

11.1 General

Where possible the survey of a ferro-cement vessel under construction is to be carried out on a continuous basis. If this is not possible the surveyor must inspect the vessel at the following stages of construction:

- (a) prior to or at the half way stage when the steel reinforcement is being erected;
- (b) when the steel reinforcement has been completely erected prior to the placement of the mortar;
- (c) during the full period of the placement of the mortar on the hull i.e. the shell and associated framework, at commencement of and at intervals during the curing process;
- (d) during the placement of the mortar on subsequent stages viz bulkheads, decks, floors;
- (e) at the stripping of any formwork;
- (f) following the completion of the curing period i.e. 10 days after steam curing and 28 days if water cured;
- (g) during subsequent fitting out; and
- (h) at any other times as the Authority may consider necessary.

11.2 Watertight Testing

11.2.1 Water tightness tests may be carried out on the hull, decks and bulkheads. These tests may be carried out by hose testing.

11.2.2 Hydrostatic tests are to be carried out on all built in tanks by filling to the top of the filling pipe.

11.2.3 The hull shall be adequately supported during these tests.

11.3 Inspections

The Authority will require inspections to be carried out during the first year of service. These inspections will take place as follows:

- (a) Out of water after 3 months;
- (b) In the water after 6 months; and
- (c) Out of water after 12 months;
- (d) Thereafter at intervals specified by the Authority.

12. Painting and Other Surface Coatings

12.1 General

12.1.1 Owing to the steel content of ferro-cement the external hull and deck surface shall be given a protective coating.

12.1.2 The hull and other parts of the vessel are not to be coated until the final survey specified in sub-clause 11.1.(f) has been completed.

12.1.3 Prior to the application of any coating the curing process must be completed.

12.1.4 All paint or surface coatings are to be applied in accordance with the manufacturer's instructions. Due regard is to be paid to surface preparation, compatibility with metal fittings and anti-fouling coatings.

12.1.5 Particular attention should be paid to engine-room bilge coatings and the surface coatings of water ballast, fresh water storage tanks and fish tanks.

13. Testing

13.1 General

13.1.1 In order to demonstrate that the materials being used and the working techniques will give satisfactory results, test panels may be required to be prepared, cured, and tested, prior to the commencement of construction.

- 13.1.2 These test panels are to be plastered in the vertical position and to be constructed in accordance with the steel reinforcing arrangements set out in the plans which have been approved by the Authority.
- 13.1.3 The sizes and number of test panels where required for both the impact and tensile tests are set out in Appendix Z.
- 13.1.4 In addition to the test panels samples of cement mortar formed in cylinders or cubes are to be prepared, cured and tested in a compression in a N.A.T.A. approved laboratory.

13.2. *Test to be Carried Out During Mortar Placement Process Slump Test*

A slump test can only be regarded as an indication to the workability of the mortar and should not take preference to the main requirement that the consistency of the mortar should be such as to give complete penetration of the steel reinforcement with the lowest possible cement/ water ration. See sub-clause 6.4. A description of the slump test and the equipment necessary are given in Appendix AA.

13.3. *Test Samples Taken During the Placement of Mortar*

During the mixing operation mortar samples are to be prepared in accordance with the instructions in Appendix AB.

13.4. *Drilling Tests*

The Authority may require drilling tests to be carried out if it is suspected that voids exist in the hull membrane.

14. Equivalent Arrangements

Where this Section requires particular materials to be used and specified the scantlings of these materials, allowance may be given for any other material and related scantlings provided the Authority is satisfied that the materials or scantlings are equivalent to those required by the Section.

15. Special Considerations

15.1. *Electrolysis*

- 15.1.1 Corrosion and degradation of the hull reinforcement may occur through electrolytic action.
- 15.1.2 This action may be caused by faulty earthing of machinery and electrical equipment, stray electric currents in dock water around vessels, dissimilar metals in propeller/shaft/ stern tube assembly.
- 15.1.3 Provision should be made for insulating steel items in contact with the water from direct contact with the hull steel reinforcement e.g. stern tubes, rudder top and bottom bearing surfaces, bull bolting arrangements for fendering, sea inlet and discharge fittings.

15.2. *Hull Insulation Arrangements*

- 15.2.1 Cargo and fishing vessels should be provided with insulation that is of adequate thickness and is correctly fitted.
- 15.2.2 The effects on the ferro-cement hull caused by a large temperature differential and the freezing of absorbed water could lead to a local failure.
- 15.2.3 Wherever possible insulated refrigerated spaces in ferro-cement vessels should not be integral with the hull.

APPENDIX-LIST OF ITEMS

Appendices to be metricated when information is received.

- A. Hull Scantlings Table.
- B. Steel Wire Gauge Table.
- C. Steel Reinforcing Rods. Table showing sizes and weights.
- D. Weights per square foot of Mesh reinforcement in common use.
- E. Sand Grading curves of the Cement and Concrete Association of Australia.
- F. Additives - General Information.
 - (a) pozzolans
 - (b) chromium trioxide
- G. Description of Methods of Construction.
 - (a) pipe frame method
 - (b) welded frame method
 - (c) wooden frame method
 - (d) frame and batten method
 - (e) female moulding method
 - (f) male moulding method
- H. Dimensions for keel bar, stem bar, and stern frame bar.
- I. Sketch showing typical keel steelwork and reinforcement.
- J. Table showing minimum thickness and area of bar keel construction.
- K. Floor scantlings table.
- L. (withdrawn)
- M. Sketch showing typical keelson or longitudinal side girder.
- N. Sketch showing typical frame/floor connection.
- O. Sketch showing typical floor/shell connection.
- P. Table showing spacing, section moduli and recommended sizes for transverse side frames.
- Q. Sketch showing typical side frame deck beam connection.
- R. Typical details for frame, bulkhead and deck starter rods.
- S. Table showing bulkhead thicknesses section moduli and recommended sizes for stiffeners.
- T. Table showing deck thicknesses section moduli and recommended sizes for deck beams (610 mm spacing).
- U. Typical deck/shell arrangement.
- V. Table showing section moduli for longitudinal girders.
- W. Measuring methods for determining quantities of materials used in mortar mix.
- X. General Information - wet and steam curing processes.
- Y. Curing Process - graph showing temperature time/curing curves.
- Z. Test Information - sizes of test pieces and tests required.
- AA. Slump Test.
- AB. Compression tests - mortar.
- AC. Table showing thickness of skeg or sole piece.

APPENDIX A

HULL SCANTLINGS TABLE

Length of vessel (metres)	Minimum hull thickness (mm)	Steel reinforcements			Hull steel weights	
		Longitudinal rods diameter and spacing	Transverse rods diameter and spacing	Mesh	Kg per square metre	Kg per cubic metre
Up to 9	18	4 mm 75 mm centres	...	4 layers { 2 @ 12.5 x 12.5 x 1.3 2 @ 12.5 x 12.5 x 1.6	9.89	549
9-12	19	5 mm 75 mm centres	...	4 layers { 2 @ 12.5 x 12.5 x 1.3 2 @ 12.5 x 12.5 x 1.6	10.60	558
12-15	20	6.3 mm 75 mm centres	...	4 layers { 2 @ 12.5 x 12.5 x 1.3 2 @ 12.5 x 12.5 x 1.6	11.79	581
15-18	29	6.3 mm 75 mm centres	3.15 mm 50 mm centres	5 layers { 2 @ 25 x 25 x 1.6 3 @ 12.5 x 12.5 x 1.6	14.81	513
18-21	31	6.3 mm 75 mm centres	5 mm 75 mm centres	5 layers { 2 @ 25 x 25 x 1.6 3 @ 12.5 x 12.5 x 1.6	15.59	508
21-24	32	7.1 mm 75 mm centres	5 mm 75 mm centres	5 layers { 2 @ 25 x 25 x 1.6 3 @ 12.5 x 12.5 x 1.6	16.44	522
24-27	36	8 mm 75 mm centres	5 mm 75 mm centres	6 layers { 3 @ 25 x 25 x 1.6 3 @ 12.5 x 12.5 x 1.6	18.84	529
27-30	37	9 mm 75 mm centres	5 mm 75 mm centres	6 layers { 3 @ 25 x 25 x 1.6 3 @ 12.5 x 12.5 x 1.6	20/19	552

APPENDIX B

STEEL WIRE GAUGE TABLE

<i>Gauge No.</i>	<i>Diameter</i>	
	<i>In.</i>	<i>mm</i>
7/0.....	.500	12.70
6/0.....	.464	11.80
5/0.....	.432	11.00
4/0.....	.400	10.16
3/0.....	.372	9.45
2/0.....	.348	8.84
0.....	.324	8.23
1.....	.300	7.62
2.....	.276	7.01
3.....	.252	6.40
4.....	.232	5.89
5.....	.212	5.38
6.....	.192	4.88
7.....	.176	4.47
8.....	.160	4.06
9.....	.144	3.66
10.....	.128	3.25
11.....	.116	2.95
12.....	.104	2.64
13.....	.092	2.34
14.....	.080	2.03
15.....	.072	1.83
16.....	.064	1.63
17.....	.056	1.42
18.....	.048	1.22
19.....	.040	1.02
20.....	.036	.91
21.....	.032	.81
22.....	.028	.71
23.....	.024	.61

APPENDIX C

**STEEL REINFORCING RODS
TABLE SHOWING SIZES AND WEIGHT**

<i>Diameter (mm)</i>	<i>Nearest gauge number</i>	<i>Weight kg/metre</i>	<i>Diameter (mm)</i>	<i>Nearest gauge number</i>	<i>Weight kg/metre</i>
12.5	7/0	0.963	7.1	2	0.311
11.2	5/0	0.773	6.3	3	0.245
10.0	4/0	0.616	5.0	6	0.154
9.0	2/0	0.499	4.0	8	0.099
8.0	1/0	0.395	3.15	10	0.061

APPENDIX D

**WEIGHTS PER SQUARE METRE OF TYPICAL
MESH REINFORCEMENT IN COMMON USE**

<i>Type of mesh</i>	<i>Dimensions (mm)</i>	<i>Weight kg/metre²</i>
Galvanized square welded.	12.5 x 12.5 x 0.8	0.8
Galvanized square welded.	12.5 x 12.5 x 1.3	1.7
Galvanized square welded.	12.5 x 12.5 x 1.6	2.6
Galvanized square welded.	25 x 25 x 1.3	0.82
Galvanized square welded.	25 x 25 x 1.6	1.3
Square welded.	12.5 x 12.5 x 0.72	0.47
Square welded.	12.5 x 12.5 x 1.2	1.4
Square welded.	12.5 x 12.5 x 1.6	2.3
Square welded.	25 x 25 x 1.2	0.69
Square welded.	25 x 25 x 1.55	1.2

APPENDIX E

RECOMMENDED SAND GRADING CURVES

Grading	British standard sieve size or No.	3/16	7	14	25	52	100	200
1	passing by weight	100	100	85	55	15	4	3
2	passing by weight	100	100	100	98	30	2	1

Note: The cement content for grading 2 is to be not less than 950 kg per cu. metre of dry sand.

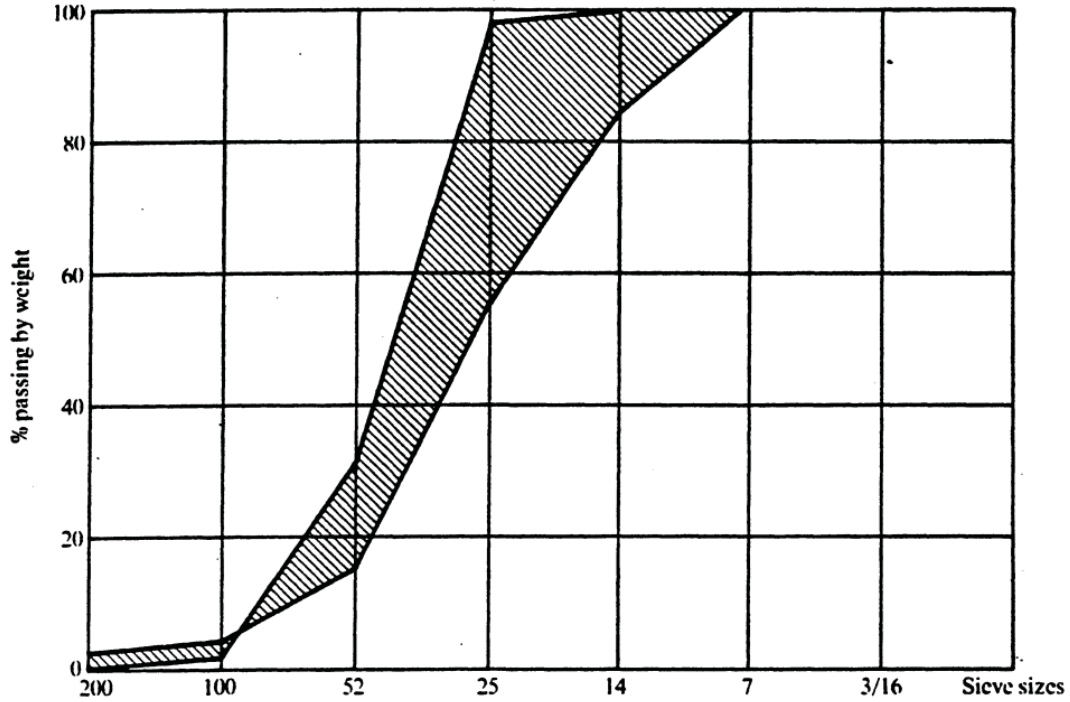

RECOMMENDED RANGE OF SAND PASSING DIFFERENT SIEVE SIZES

APPENDIX F

ADDITIVES – GENERAL INFORMATION

1. Pozzolans

- 1.1 The most common pozzolans available today are fly ash and diatomaceous earth.
- 1.2 They may be added to the mix as a replacement for up to 10% of the cement. Although some of the cement is replaced by pozzolans the water / cement ratio does not include an allowance for the pozzolans.
- 1.3 The purpose of these materials is to increase the resistance of the mix to sulphate attack and to improve its workability. They do not increase the curing time of the cement.
- 1.4 Technical advice should always be obtained to confirm that the pozzolanic material, intended for use, is compatible with the cement.

2. Chromium Trioxide

- 2.1 The purpose of adding chromium trioxide to the mix water is to obtain maximum oxidation of the zinc galvanizing on the mesh.
- 2.2 Chromium Trioxide may be added to the mix water to a maximum of 300 parts per million. This is equivalent to 0.36 grams per litre of water.
- 2.3 Australian cements contain varying amounts of CrO_3 , an average figure being 60 p.p.m. Actual figures are available from the manufacturers, and should be taken into account when adding CrO_3 .

3. Water Reducing Agents

- 3.1 The purpose of adding these agents, which are in liquid form, is to reduce the water/cement ratio and thereby produce a mortar which sets to give a stronger and less permeable cement.
- 3.2 Most water reducing agents have a lignin sulphonic base. They are added to the mix proportionately to 100 kgs of cement.
- 3.3 When using these agents the manufacturer's instructions must be strictly adhered to.

4. Initial Set Retarding Agents

- 4.1 The purpose of adding these agents is to retard the setting time of the cement by controlling the rate of hydration and thus giving extended placement and finishing time during warm weather conditions.
- 4.2 By using these retarding agents the setting time at 20°C could be extended by 2 to 4 hours.
- 4.3 These agents have a calcium lignin sulphonate base. They are added to the mix proportionately to 100 kgs of cement.
- 4.4 The manufacturer's instructions must be strictly adhered to when using retarding agents.

5. Air Entraining Agents

- 5.1 The purpose of adding these agents is to improve the workability, placeability and to a limited extent reduce the water content of the mix.
- 5.2 These agents have sulphonated petroleum hydrocarbon base and are added to the mix proportionately to 100 kg of cement.
- 5.3 The manufacturer's instructions must be strictly adhered to when using air entraining agents.

**APPENDIX G
METHODS OF CONSTRUCTION**

1. Pipe Framework Method

- 1.1 In this method steel pipes are shaped from the lofted lines for each frame station.
- 1.2 From an overhead baseline the steel pipes are secured in position and tack welded. The stem, keel, stern and transom pipes are then welded into place. Whenever the frame work has been checked for fairness and found to be satisfactory it can then be welded up.
- 1.3 The longitudinal rods are placed on the outside of the frame and secured by wire; transverse rods are then fitted and secured. The inner and outer layers of mesh are applied and securely attached to the rods by wire.
- 1.4 The pipe framework may or may not be incorporated in the hull reinforcement.
- 1.5 In either case the pipes should be sufficiently strong to retain their shape under the weight of the wet mortar cement.
- 1.6 Whenever the hull reinforcement has been checked for continuity of thickness overall and found to be satisfactory the cement mortar can be applied.
- 1.7 This method may be used in vessels up to 16 metres in length thereafter the web frame system requires to be adopted.

2. Welded Frame Method

- 2.1 This method is suitable for all vessels and is recommended when the vessels length is in excess of 16 metres.
- 2.2 Prefabricated frames are made up from the lofted lines at the requisite spacing.
- 2.3 These frames are made up of round or square sections welded together, are very strong, and consequently retain their shape under heavy loads.
- 2.4 The frames are positioned by attaching to the keel steelwork at the bottom and struts to the roof trusses at the top.
- 2.5 The longitudinal reinforcing rods are then attached to the frames by tie wires and the mesh applied to the inside and outside of the hull.
- 2.6 The mortar is then applied and the frames are 'plastered in' to the hull.
- 2.7 In some cases the frames can act as ground bars for a bulkhead which is lapped on them and secured by closely spaced steel bolts.

3. Wooden Frame Method

- 3.1 This method is primarily used for small vessels with an upward limit of about 12.5 metres in length.
- 3.2 The frames are made from good quality timber which has sufficient strength to retain its shape during the construction process.
- 3.3 The frames are made up in the correct shape positioned by longitudinal battens and the steel reinforcement is applied. The internal layers of mesh are loosely laid across the frames followed by the longitudinal steel rods which are stapled into position on the frames. Finally the outside layers of mesh are fixed and the mesh and rods secured with tie wires.
- 3.4 When the shell reinforcement is completely secured with tie wires and satisfactorily faired the cement mortar is applied.
- 3.5 Care must be taken when removing the wooden frames.
- 3.6 In some cases plywood frames are used in this method and 'plastered in' with the shell.

4. Female Moulding Method

- 4.1 The female moulding method appears to have a great potential for ferro-cement boat construction.
- 4.2 The placement of the mesh within the mould presents problems as it is difficult to keep in the correct shape. On the other hand internal bulkheads, stiffeners, frames and other attachments can be positioned and secured to the mesh before plastering begins, thus resulting in considerable time saving.

- 4.3 Another disadvantage is attaining an adequate mortar cover on the outermost layer of mesh on the hull exterior owing to contact with mould during the plastering process. This can be overcome by providing an additional outer cover later on.
- 4.4 The mould imparts a quality finish on the exterior of the shell and furthermore the shrinkage of the mortar during the curing process aids the boat's release from the mould.
- 4.5 The only size restriction for this method of moulding would relate to the space available and possibly weight considerations in handling the mould.

5. Male Moulding Method

- 5.1 The male moulding method involves using a mould which has a limited application, since only boats of a simple design can be obtained from it. The framework for this mould can either be in a single piece or sections which can be removed once the hull has been cast. Some of the disadvantages and/or difficulties which arise with this method are:
- (a) placement of steel reinforcement so that it does not contact the mould face.
 - (b) obtaining complete mortar penetration.
 - (c) avoidance of mortar shrinkage.
 - (d) attachment of structural members to the internal (smooth) surface.
- 5.2 Its main advantage is quickness and minimum amount of labour required.
- 5.3 There would appear to be a limit on the size of vessel which could be produced by this method.

6. Frame and Batten Method

- 6.1 The frame and batten method consists of longitudinal wooden battens, spaced 50 to 75 mm apart, which are secured to pipe, welded or wooden frames, and form a male mould around which the boat can be built.
- 6.2 The battens must be treated with a special preservative as they may be 'plastered in' or left in contact with the interior shell surface.
- 6.3 Layers of wire mesh are fastened directly to the battens and, if required, longitudinal and transverse reinforcing rods. The latter would be necessary in vessels over 16 metres in length.
- 6.4 When the steel reinforcement has been satisfactorily applied the boat is then 'plastered up'.
- 6.5 This form of construction is very strong and relatively simple but has disadvantages in that complete mortar penetration behind the battens is difficult to obtain and if the battens are removed later on hull damage could occur during the removal process.

APPENDIX H

DIMENSIONS FOR KEEL BAR, STEM BAR, AND STERN FRAME BAR

Length of vessel (metres)	Pipe size O.D. x thickness (mm)	Rectangular steel bars (mm)
9.....	33.4 x 4.55	50 x 10
12.....	42.4 x 4.85	65 x 10
15.....	48.3 x 5.08	75 x 10
18.....	..	75 x 12
21.....	..	100 x 12
24.....	..	130 x 12
27.....	..	130 x 16
30.....	..	150 x 16

APPENDIX I

SKETCH SHOWING TYPICAL KEEL STEELWORK AND REINFORCEMENT

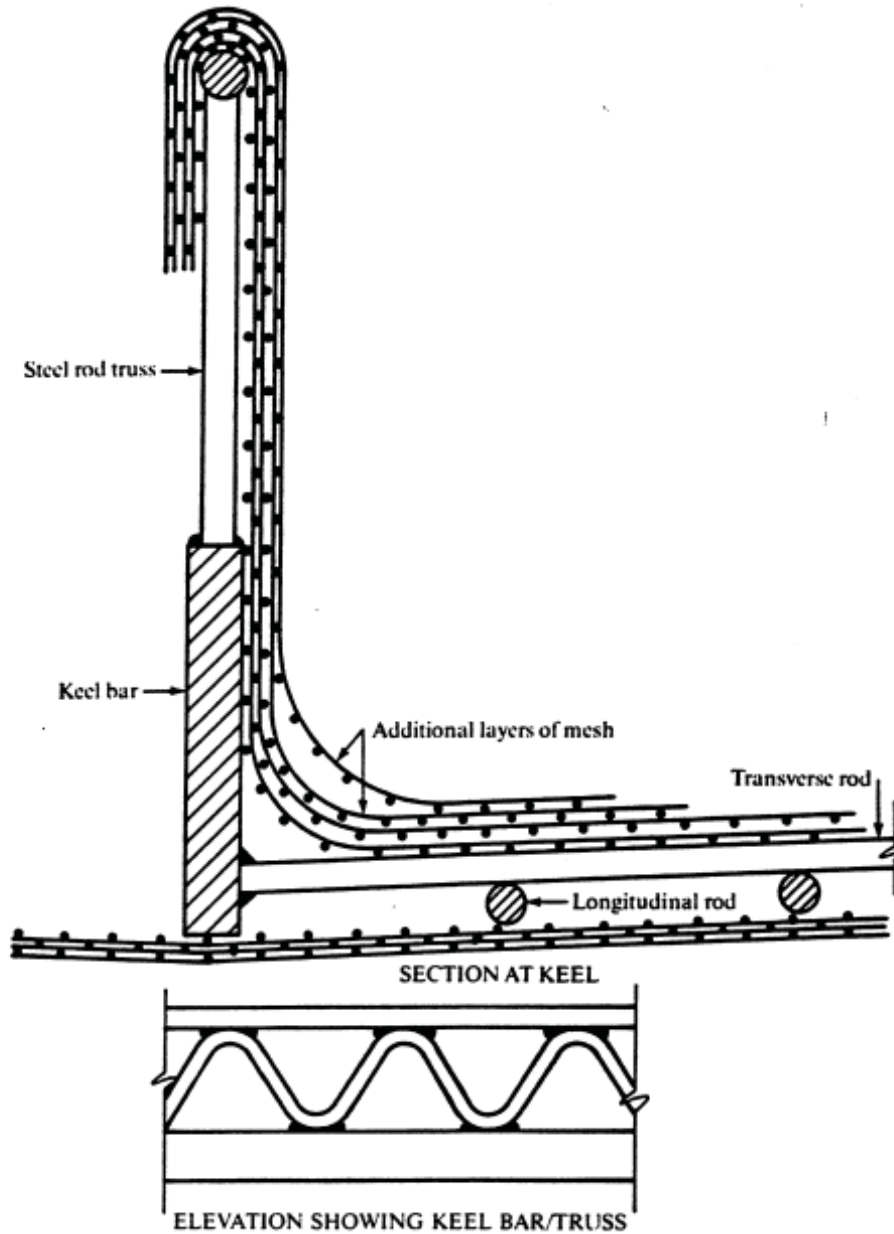

APPENDIX J

TABLE SHOWING MINIMUM THICKNESS AND AREA OF BAR KEEL CONSTRUCTION

Length of vessel (metres)	Minimum thickness (mm)	Minimum Area (mm ² x 10 ³)
9.....	150	16.1
12.....	175	41.9
15.....	200	64.5
18.....	225	90.3
21.....	250	116.1
24.....	265	138.7
27.....	280	164.5
30.....	280	190.3

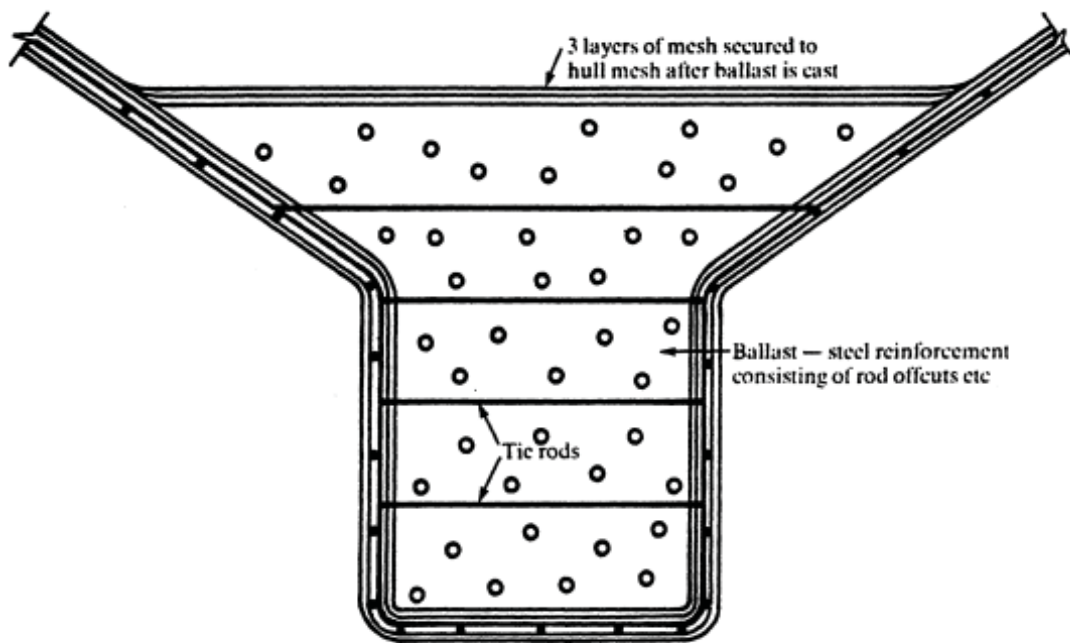

KEEL SECTION

TYPICAL BAR KEEL ARRANGEMENT

APPENDIX K

FLOOR SCANTLINGS TABLE

Moulded depth of vessel (metres)	Minimum floor sizes depth x thickness (mm)
1.5	215 x 19
1.7	230 x 19
1.8	230 x 25
2.0	240 x 25
2.1	255 x 32
2.3	265 x 32
2.4	265 x 38
2.6	275 x 38
2.7	280 x 38
3.0	305 x 38
3.4	320 x 38

APPENDIX L

SKETCH SHOWING TYPICAL PREFABRICATED STERN TUBE ARRANGEMENT

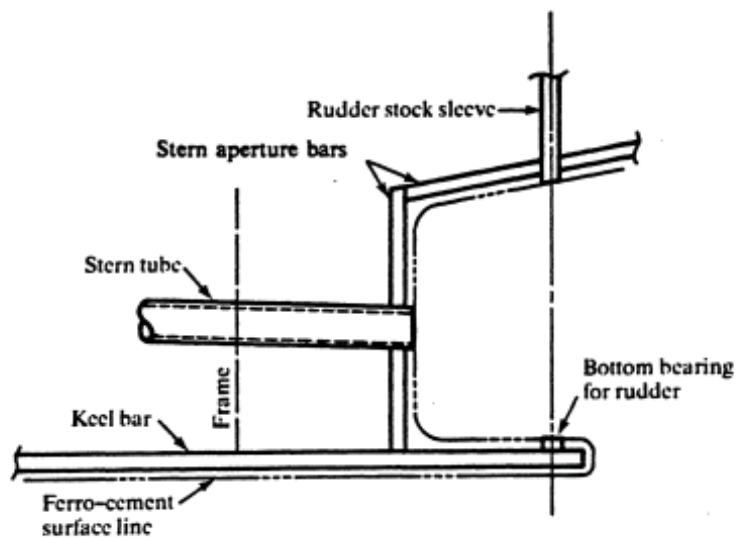

APPENDIX M

SKETCH SHOWING TYPICAL KEELSON OR LONGITUDINAL SIDE GIRDER

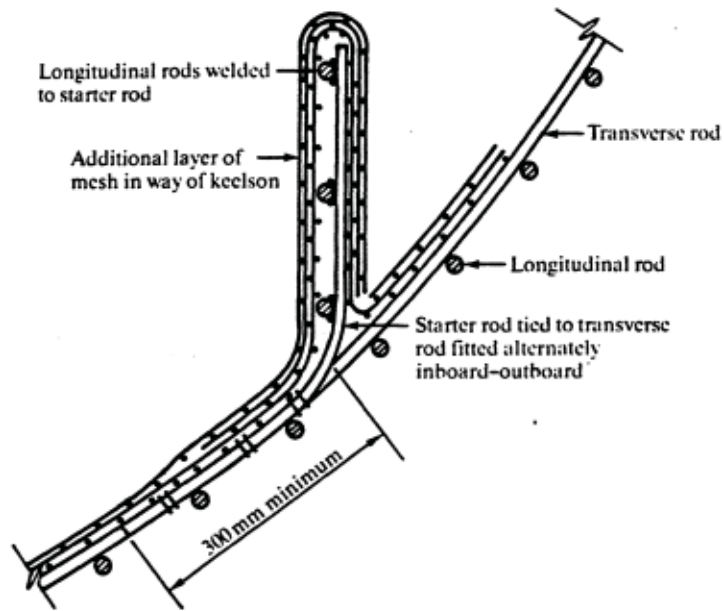
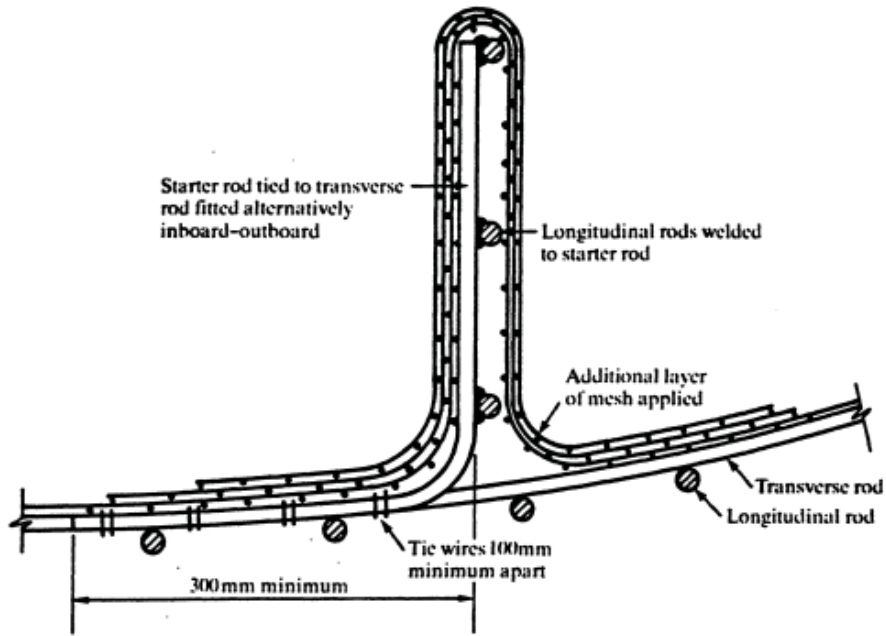

APPENDIX N

SKETCH SHOWING TYPICAL FRAME / FLOOR CONNECTION

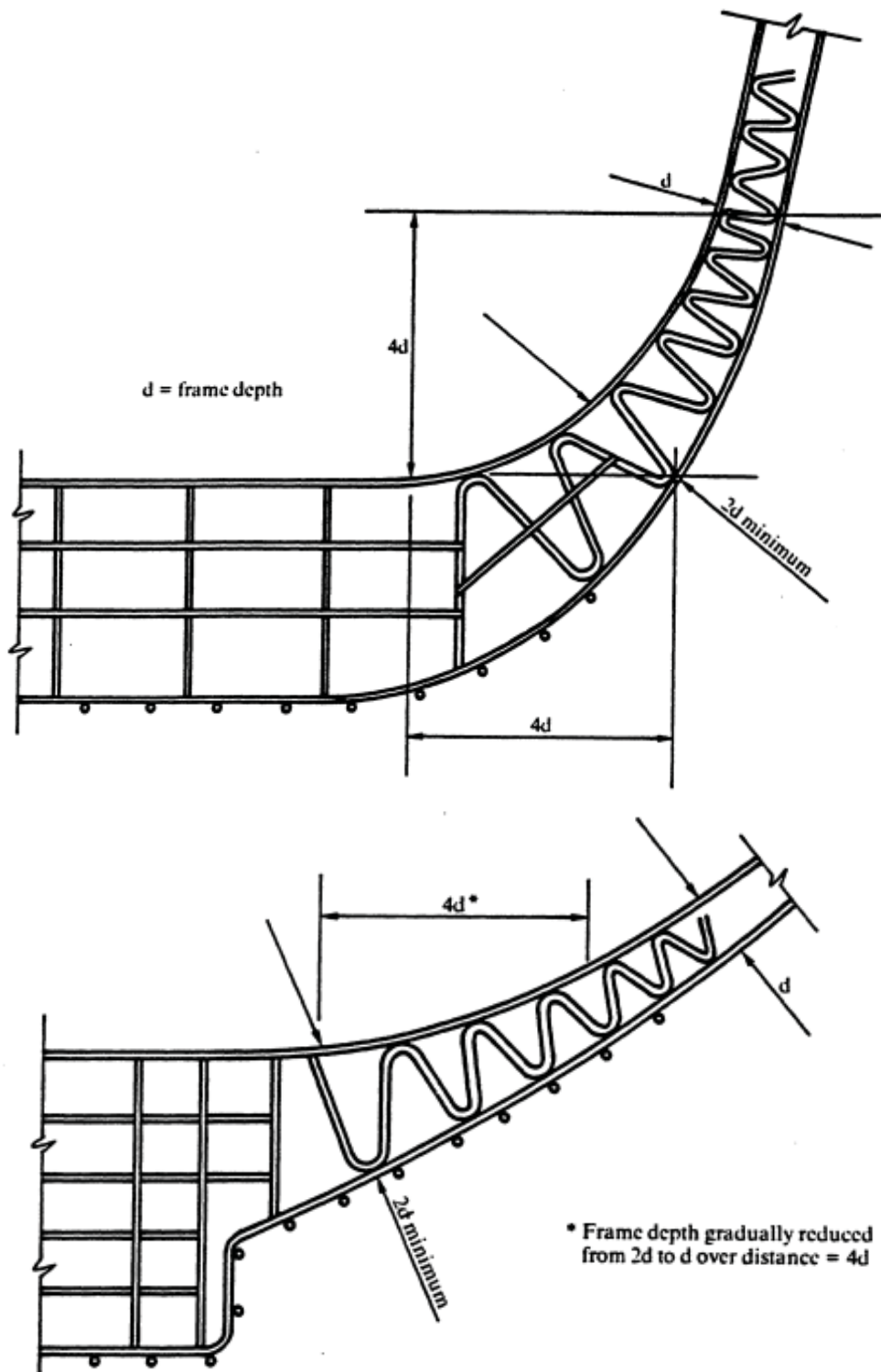

APPENDIX O

SKETCH SHOWING TYPICAL FLOOR / SHELL CONNECTION

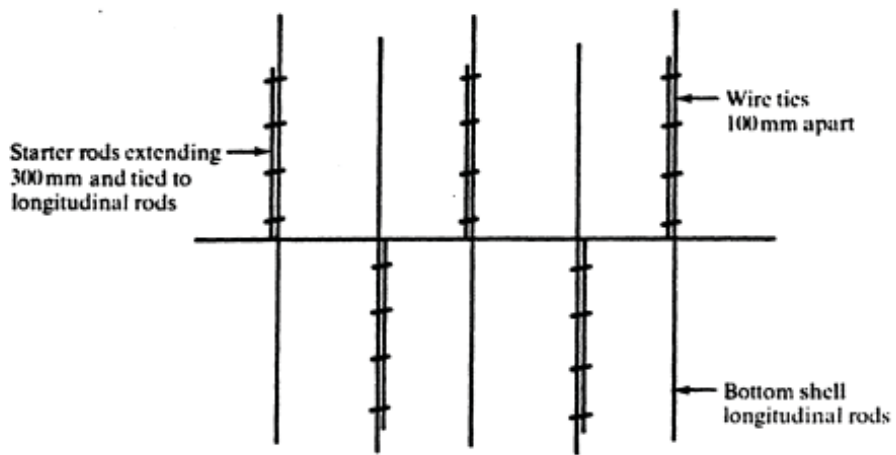
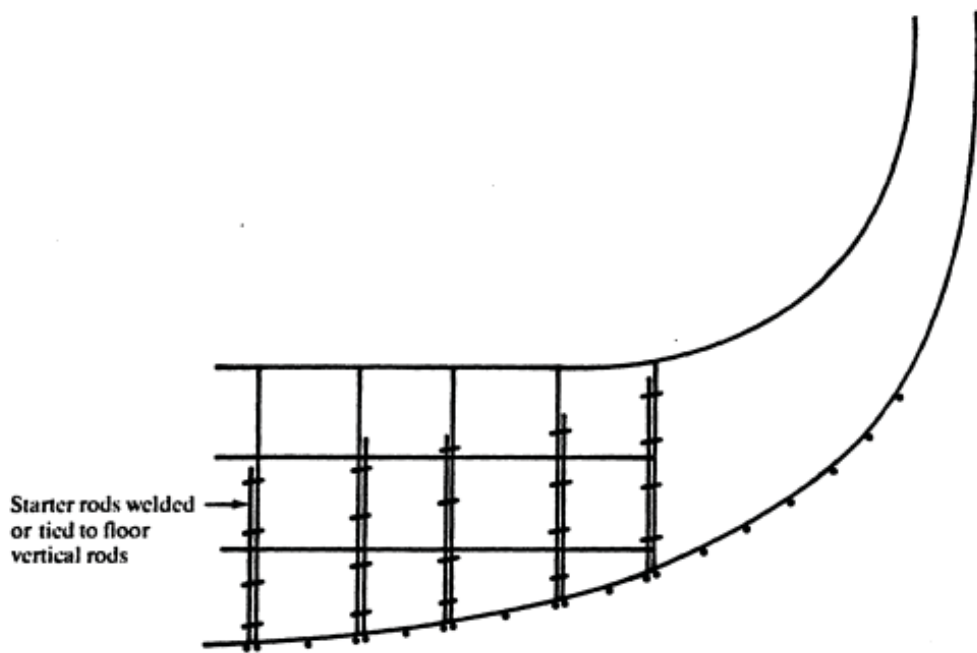

PLAN VIEW

APPENDIX P

TABLE SHOWING SPACING, SECTION MODULI AND RECOMMENDED SIZES FOR TRANSVERSE SIDE FRAMES

Unsupported length of frame (metres)	Frame spacing (mm)	Minimum I/y (mm ³ x 10 ³)	(mm x mm)
1.5	610	29.5	19 x 64
1.8	610	50.9	25 x 64
2.1	610	80.3	32 x 64
2.4	610	121.3	38 x 76
2.7	560	159.0	38 x 89
3.0	560	216.3	38 x 114

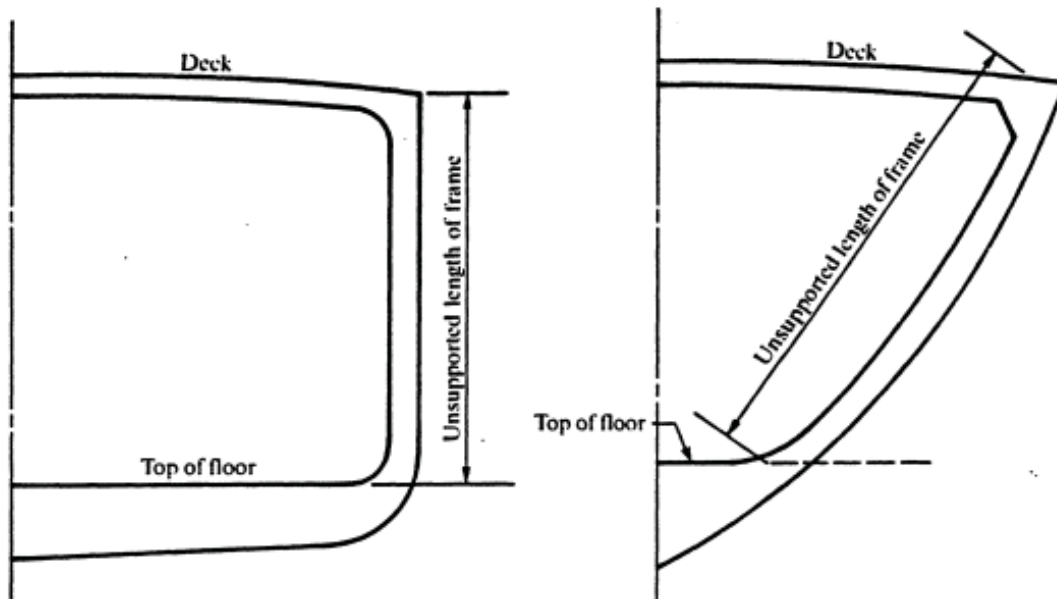

Note: Where the frame spacing is increased / decreased, the I/y value should be increased / decreased in direct proportion.

APPENDIX Q

SKETCH SHOWING TYPICAL SIDE FRAME / DECK BEAM CONNECTION

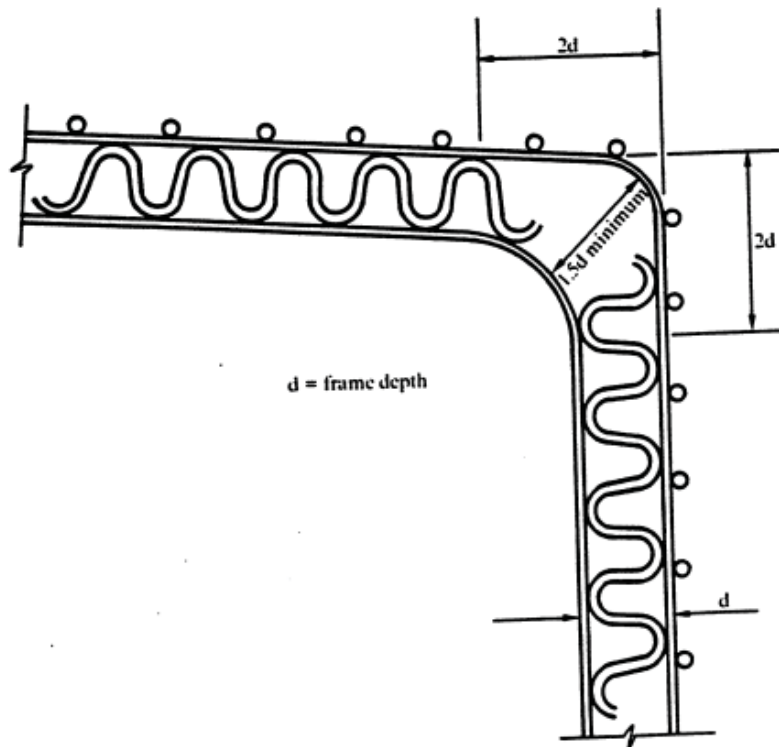

APPENDIX R

TYPICAL DETAILS FOR FRAME, BULKHEAD, AND DECK STARTER RODS

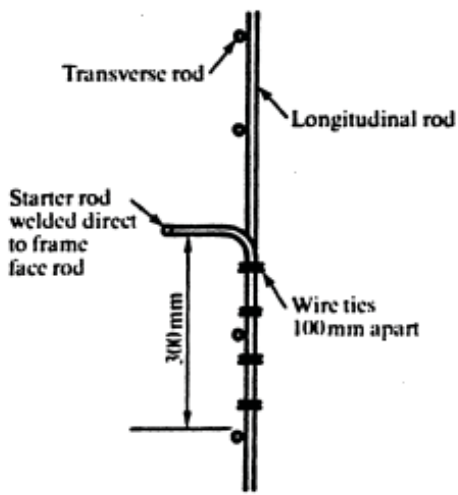

PLAN OF FRAME

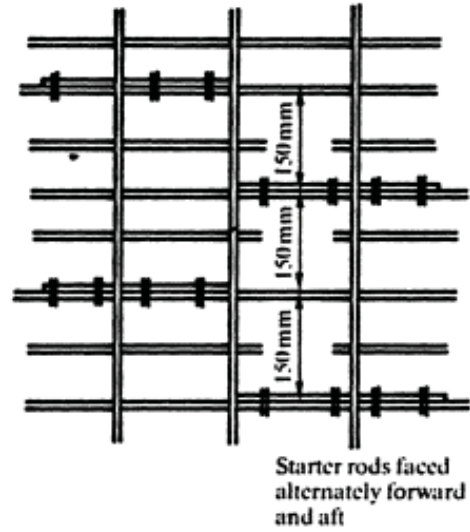

ELEVATION OF FRAME OR BULKHEAD-LOOKING OUTBOARD

Note: If frames and bulkheads are made up as individual units they may be tied directly to the hull longitudinal rods.

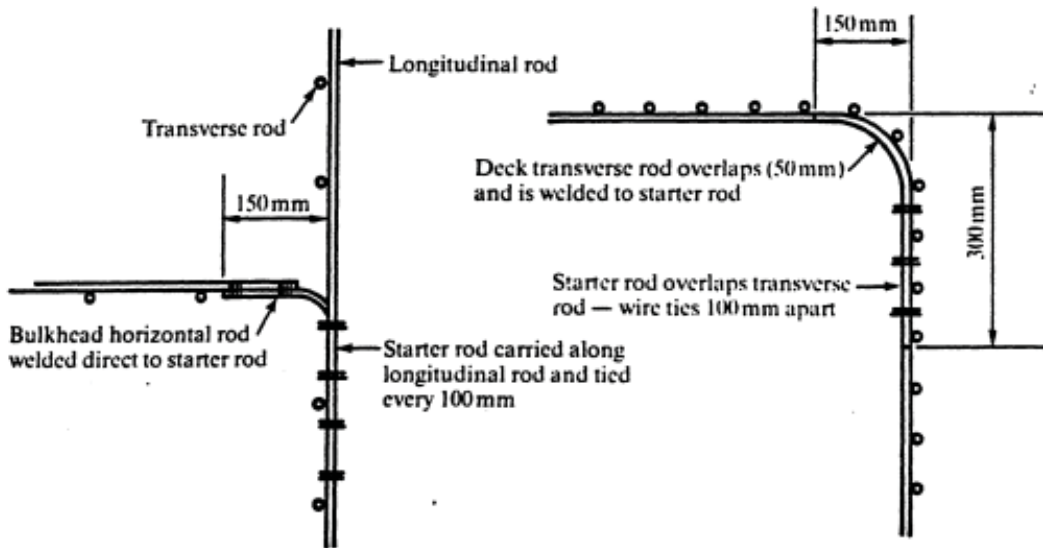

PLAN OF BULKHEAD

SECTION AT DECK

APPENDIX S

**TABLE SHOWING WATERTIGHT BULKHEAD THICKNESSES, SECTION MOD-
ULI AND RECOMMENDED SIZES FOR STIFFENERS**

<i>Height of bulkhead (metres)</i>				<i>Thickness (mm)</i>
1.5				19
1.8				25
2.1				29
2.4				23
2.7				25
3.0				38

<i>Unsupported span of beam (metres)</i>	<i>Minimum I/y (mm³ x 10³)</i>	<i>Recommended beam size (mm)</i>	<i>Deck thickness (mm)</i>
1.5	610	19.7	19 x 38
1.8	610	34.4	25 x 51
2.1	610	55.7	29 x 51
2.4	610	81.9	32 x 57
2.7	610	118.0	35 x 76
3.0	610	162.2	38 x 89

Note: Where the stiffener spacing varies from 610 mm the section modulus (I/y) may be modified in direct proportion.

APPENDIX T
TABLE SHOWING DECK THICKNESS, SECTION MODULI AND RECOMMENDED SIZES FOR
DECK BEAMS (610 mm SPACING)

<i>Length of Vessel (metres)</i>	<i>Thickness (mm)</i>
9	19
12	22
15	25
18	29
21	32
24	35
27	38
30	38

<i>Unsupported span of beam (metres)</i>	<i>Minimum I/y ($mm^3 \times 10^3$)</i>	<i>Recommended beam size (mm)</i>	<i>Deck (mm)</i>
1.2	24.6		
1.5	36.1	25 x 51	25
1.8	45.9		
2.1	57.4	29 x 51	29
2.4	73.7		
2.7	101.6	32 x 76	32
3.0	114.7		
3.4	142.6	38 x 76	38
3.7	185.2		
4.0	245.8	38 x 114	38
4.3	314.6		
4.6	419.5		

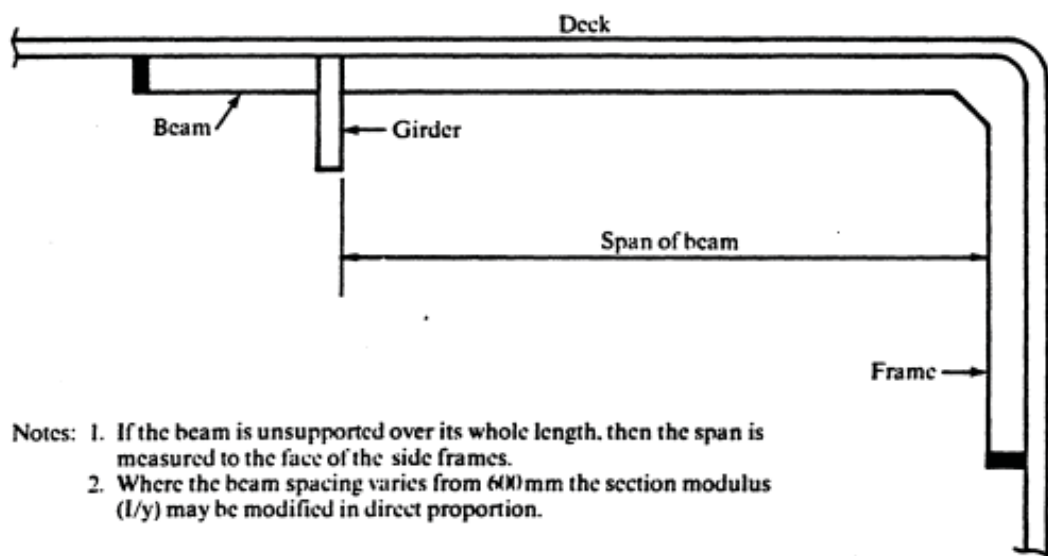

- Notes: 1. If the beam is unsupported over its whole length, then the span is measured to the face of the side frames.
 2. Where the beam spacing varies from 600mm the section modulus (I/y) may be modified in direct proportion.

APPENDIX U

TYPICAL DECK / SHELL ARRANGEMENT

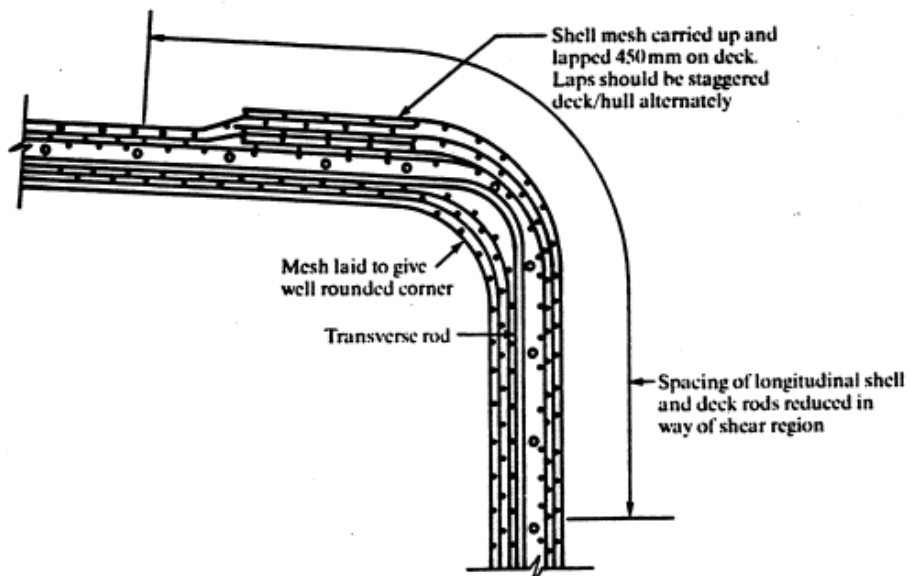

SECTION – DECK CORNER

TYPICAL DECK / SHELL / BULLWARK ARRANGEMENT

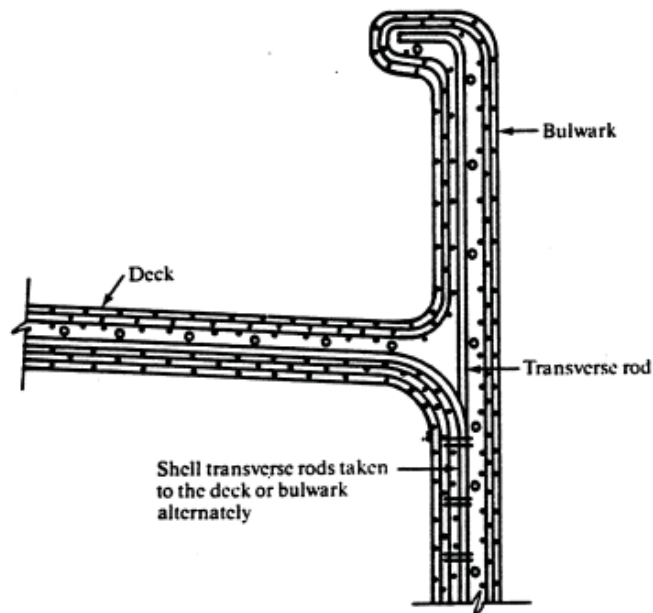

SECTION – AT DECK

APPENDIX U

TYPICAL FREEING PORT / BULLWARK ARRANGEMENT

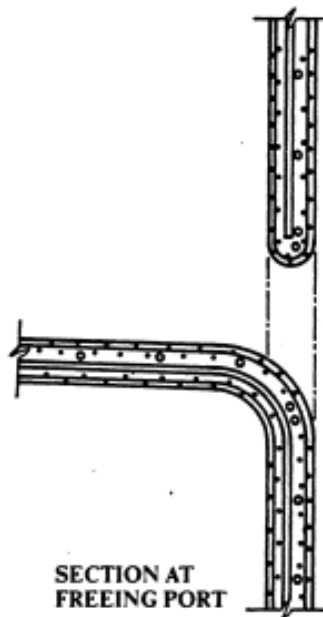
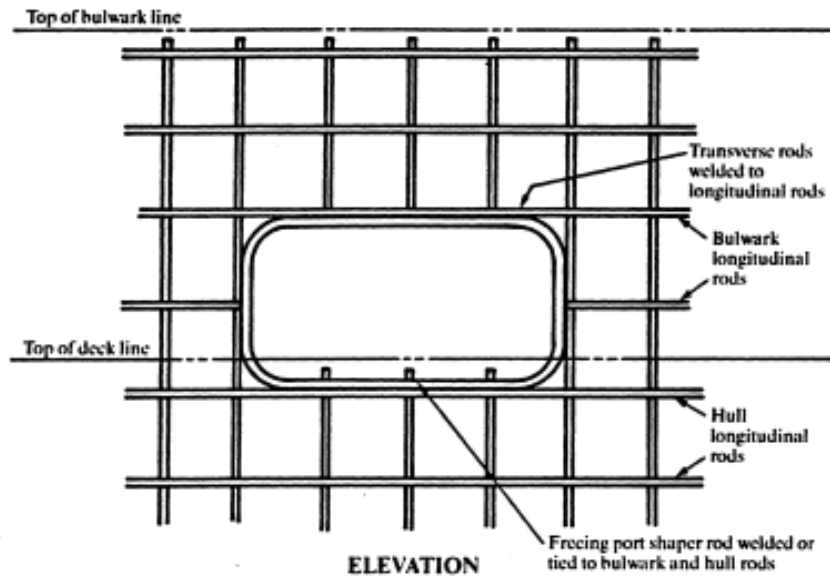

APPENDIX V

TABLE SHOWING SECTION MODULI FOR LONGITUDINAL GIRDERS

Unsupported span of girder (metres)	Section moduli I/y ($mm^3 \times 10^3$)				
	Width of deck supported by girder				
	0.6 m	1.2 m	1.8 m	2.4 m	3.0 m
1.8	45.9	91.8	137.7	183.5	229.4
2.4	73.7	147.5	221.2	295.0	368.7
3.0	114.7	229.4	344.1	458.8	573.5
3.7	185.2	370.3	555.5	740.7	925.9
4.3	314.6	629.3	943.9	1 258.5	1 573.2
4.9	594.9	1 189.7	1 784.6		

Notes:

1. The depth of girder should not exceed 5 x width (mm)
2. The section modulus (I/y) of the girder is to be calculated on the basis that a 610 mm wide deck panel is an integral part.

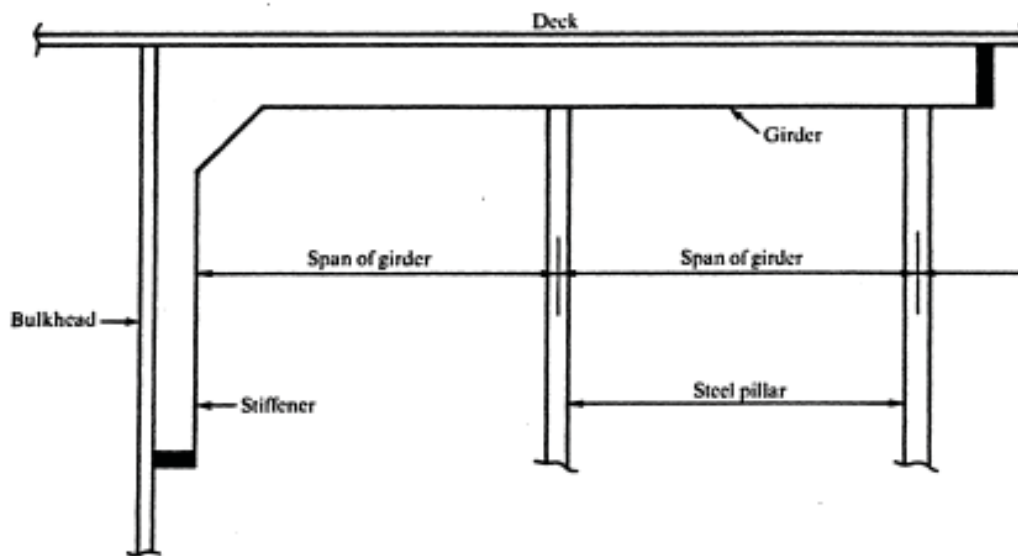

APPENDIX W
MEASURING METHODS

1. General

1.1 In order to obtain mortar which has the desired water/ cement and cement/sand ratios it is necessary to adopt correct measuring methods for determining the amounts of sand, cement and water prior to the mixing operation.

1.2 There are two methods which give satisfactory results viz.:

1.2.1 batching by volume; and

1.2.2 batching by weight

The latter method is the more accurate of the two.

2. Cement Particulars

2.1 A bag of cement in Australia should have a net weight of 42.4 kg.

2.2 One cubic metre of cement weighs 1360 kg.

3. Cement/Sand Ratio

3.1 This ratio relates to the weights of the two products.

3.2 This ratio should vary between 0.70 and 0.40 so that shrinkage is kept to a minimum.

3.3 Minimum shrinkage occurs when $\frac{\text{cement}}{\text{sand}}$ (wts) = 0.50

4. Water/Cement Ratio

4.1 This ratio relates to the weights of the two products.

4.2 This ratio shall not be less than 0.30 nor more than 0.50 from porosity and permeability considerations.

5. Moisture Content of Sand

5.1 It will be necessary to obtain the average moisture content of the sand (expressed in per cent by weight) as very seldom is it completely dry.

5.2 Whenever this has been established, the weight of water to be added can be adjusted when mixing the mortar.

6. Batching by Volume

6.1 The quantities used are related to the volume of a bag of cement (42.4 kg in weight) which has a volume of 0.03 cu. m.

6.2 The volume of sand required could be obtained by filling up a wooden box of predetermined volume and levelling off the sand on the top. The predetermined volume would be related to the cement/sand ratio decided upon for the mortar.

6.3 Sand containing moisture has a tendency to bulk and this must be allowed for when deciding the internal dimensions of the box.

6.4 Example: The mortar is to have a cement/sand ratio of 0.5 and a water/cement ratio of 0.4. Determine volumes to be used for each batch on the basis of 1 bag of cement.

Volume one bag of cement - 0.03 cu. m.

Volume of dry sand - $2 \times 0.03 = 0.06$ cu. m.

Water required = 42.4×0.4

= 17.0 kg or 17.0 litres.

Assuming moisture content of sand is 4 per cent.

This water has a volume of

$$\frac{42.4 \times 2 \times .04}{1} = 3.4 \text{ litres}$$

∴ Required water to be added
= 17.0 - 3.4 = 13.6 litres.

7. **Batching by Weight**

7.1 This method involves relating the weights of the quantities used with the weight of the cement (a bag weighs 42.4 kg).

7.2 All items would be weighed out prior to, or during the mortar mixing process.

7.3 Example: Mortar to have cement/sand ratio 0.5, water/cement ratio 0.4. The sand has a 5 per cent moisture content. Determine the weights for the mix on the basis of one bag of cement. \

1 bag cement weight 42.4 kg

$$\text{Dry weight of sand required} = \frac{42.4}{0.5} = 84.8 \text{ kg}$$

$$\text{Actual weight of sand used} = \frac{84.8}{.95} = 89.3 \text{ kg}$$

$$\text{Moisture content of sand} = 89.3 - 84.8 = 4.5 \text{ kg}$$

$$\text{Water required} = 42.4 \times 0.4 = 17.0 \text{ kg}$$

$$\begin{aligned} \text{Actual water to be added} &= 17.0 - 4.5 \\ &= 12.5 \text{ kg.} \end{aligned}$$

APPENDIX X
CEMENT CURING PROCESSES

1. Curing-General Information

- 1.1 The hydration process, by which cement gel is formed from cement powder plus water, is relatively slow and is considered to be 60 per cent complete within 7 days and almost completed by 28 days. Thereafter the hydration process may take many years before completion is reached.
- 1.2 Hydration cannot take place without water and if the mixing water is allowed to escape from the hull the resultant hydration will cause a reduction in the strength and durability of the cement.
- 1.3 The process of retaining water in the cement during this early period is called 'curing'.
- 1.4 The temperature at which curing takes place is equally important. When the temperature falls to freezing point, the hydration process ceases completely, at temperatures close to freezing point the process is severely retarded.

2. Steam Curing

Note: Attention is drawn to the recommended practice for the low pressure steam curing of concrete as set out in AS 3600 (Concrete structures).

(Amendment dated 1 October 2008)

- 2.1 When it is possible to construct the hull in a single plastering operation steam curing is both desirable and advantageous subject to stringent control.
- 2.2 Sufficient time should be allowed after plastering has been completed to allow the last mortar applied to set properly - this should take 4 to 5 hours.
- 2.3 The steam can be provided from any source and should be of low pressure ('wet' steam).
- 2.4 Steam generators which are used for cleaning purposes e.g. car engines in garages, are suitable and readily available.
- 2.5 During the process the hull should be covered with plastic sheets, sealed at joints to prevent loss of steam.
- 2.6 The steam should be applied along the bottom of enclosure well clear of the hull.
- 2.7 During the first three hours the steam temperature should be gradually increased within the plastic envelope until the desired 71°C is obtained. This temperature should be maintained for 6 hours, and thereafter it should be allowed to cool gradually over a minimum period of 4 hours. In this respect a longer cooling period than 4 hours is desirable and under no circumstances should rapid cooling be allowed.
- 2.8 Further work on the hull can be resumed after curing.
- 2.9 This process causes considerable laitence on mortar surfaces and this must be dealt with in preparing surfaces for painting.
- 2.10 Steam curing although it may mean a quicker working of a yard ultimately tends to produce less durable more porous and less strong concrete in comparison with normal temperature (spray curing methods) this is particularly true of inexpert steam curing which may damage a hull permanently without this becoming obvious in the early stages of the hull's life.

3. Wet Curing

- 3.1 Curing can be accomplished by covering the hull, immediately after plastering has been completed, for a period of at least twenty-eight days.
- 3.2 To counteract the evaporation caused by air seeping underneath the covering, it is usually necessary to provide additional humidity by means of water sprays or evaporation trays around the hull.
- 3.3 Moist curing can be achieved by covering the hull with hessian and keeping it constantly wet using water sprays.
- 3.4 A plastic envelope over the hull and trays of water inside and outside the hull will provide good moist curing conditions.
- 3.5 The ideal temperature for curing is 21°C and the minimum 10°C.

- 3.6 Intermittent spraying is of little value as a means of curing.
- 3.7 If there are interruptions in the curing process they should be kept to the minimum, otherwise 'drying out' could occur causing shrinkage cracking.

APPENDIX Y

CURING PROCESS – GRAPH SHOWING TEMPERATURE / TIME CURING CURVE

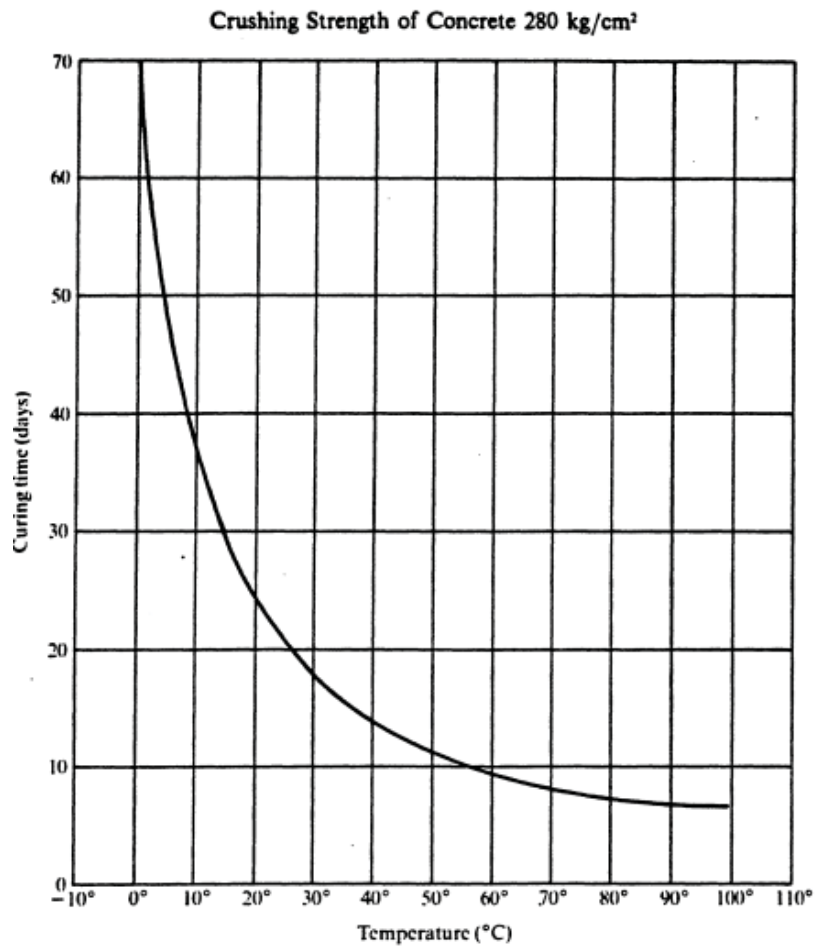

APPENDIX Z

TEST INFORMATION

1. Test panels and cubes required by the Authority are to be prepared by the builder and cured for 28 days. As soon as possible after the completion of curing they are to be tested.
 - 1.1 The Impact Test may be carried out at the builder's yard or some other suitable place designated by the Authority.
 - 1.2 The Bend Tests are to be carried out at a Testing Establishment recognised by the Authority.
 - 1.3 The Compression Tests are to be carried out at a Testing Establishment recognised by the Authority.
2. **The tests are:**
 - 2.1 *Bend Test*
 - 2.1.1 Four test pieces 1.0 metre long x 0.25 metre wide are to be prepared. Three of these are to be tested.
 - 2.1.2 The Bend Test is to be carried out on a centre loading testing machine.
 - 2.1.3 A special bend test piece support may be necessary in cases where the test pieces have become twisted during preparation.
 - 2.1.4 The Bend Test Criterion is:
Modulus of Rupture = 30 MPa
 - 2.1.4.1 The modulus of rupture is to be calculated from the formula:
$$\frac{14.7 wl}{bd^2} \times \frac{1}{10^6} \text{ (Mega Pascals)}$$
where:
w= load in kilograms,
l = distance between the supports in metres,
b= breadth of the test piece in metres,
d= thickness of the test piece in metres.
 - 2.2 *The Impact Test*
 - 2.2.1 Two test pieces 1.0 metre long x 1.0 metre wide are to be prepared.
 - 2.2.2 The Impact Test is performed by dropping a weight on the face of the test piece. The test piece is placed in a horizontal position and supported by a specially constructed metal frame.
 - 2.2.3 The number of weight drops to be carried out is dependent upon the thickness of the test piece. This number (taken to the nearest whole number) is to be calculated from the formula:
0.2 x the test piece thickness in millimetres
or
5 x the test piece thickness in inches.
 - 2.2.4 When the required number of weight drops has been completed, all loose dust and material are to be removed from the indentation in the test piece. The test piece will be assumed to be watertight if with the indentation kept filled with water there is no measurable water flow through the damaged area within a period of two minutes.
 - 2.2.5 Two complete drop tests are to be carried out on each test piece.
 - 2.2.6 Details of the drop test apparatus are shown in Appendix Z, Sketch 1.
 - 2.2.7 The size and shape of the drop weight nose cone must be the same as that shown in Appendix Z, Sketch 1. Additional weight may be added to the drop weight, and the drop height varied, provided the potential energy for each drop is equivalent to that of a 2 kilogram mass dropped from a height of 2 metres.
 - 2.2.8 Drop Test Criteria

- 2.2.8.1 The test piece is still to be watertight after the number of weight drops, specified in paragraph 2.2.3 above, have been completed.
- 2.2.8.2 The damaged areas of the test piece are not to exceed:
 - .015 sq metres on the top face, and
 - .03 sq metres on the bottom face.
- 2.3 *Compression Test*
- 2.3.1 Four 100 millimetre standard test cubes are to be prepared. Three of these are to be tested.
- 2.3.2 A minimum crushing strength of at least 34.5 MPa must be obtained.

APPENDIX Z SKETCH 1
IMPACT TEST APPARATUS

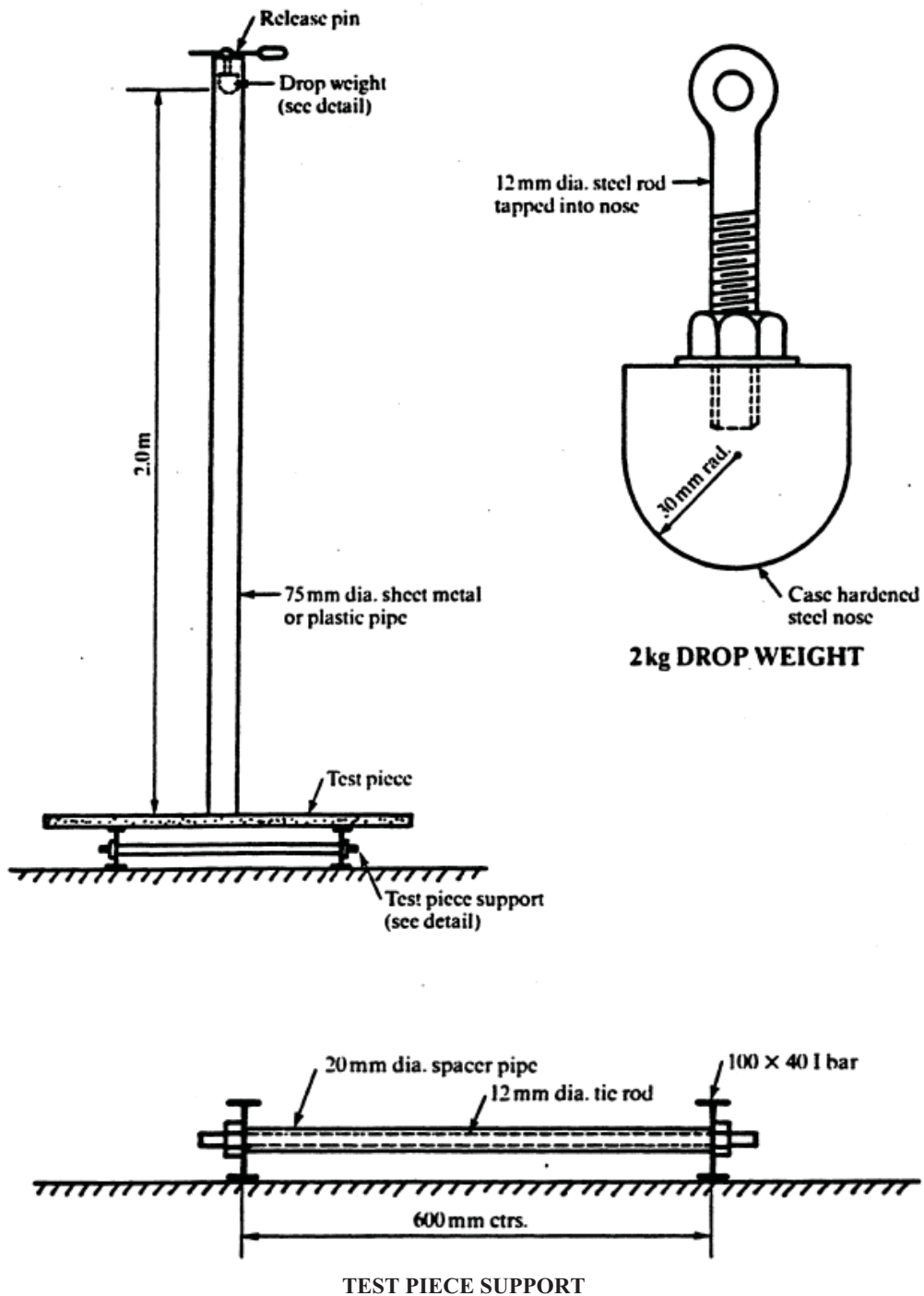

APPENDIX AA

1. Slump Test

- 1.1 The slump test is a method of testing the workability of the mortar.
- 1.2 A standard metal slump cone is to be filled with 4 layers of mortar; each layer is to be thoroughly compacted with a steel rod. The last layer which fills the cone to the top is to be trowelled flat.
- 1.3 The cone is then removed and the height reduction (slump) of the mortar is measured. A 60 mm slump in the standard cone height is considered to be the maximum acceptable amount.

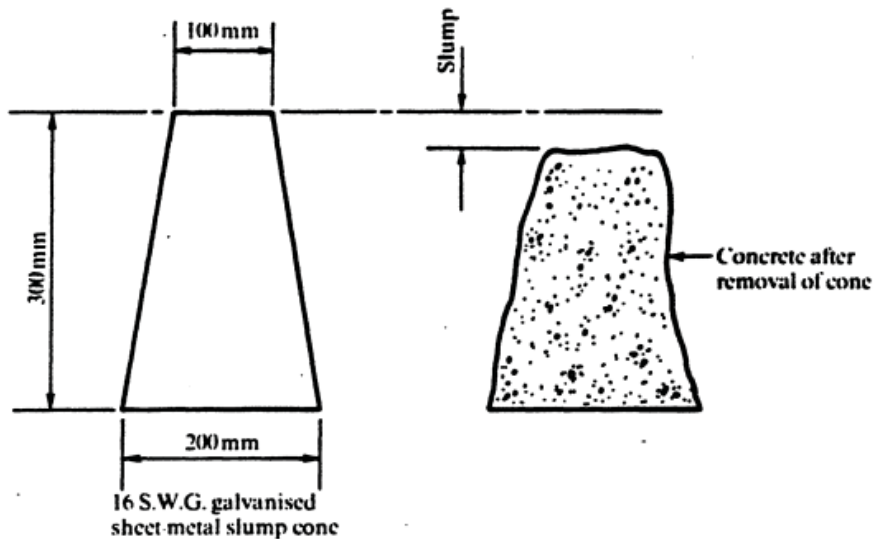

APPENDIX AB

COMPRESSION TESTS – MORTAR

1. Standard 100 millimetre test cubes of the mortar are to be prepared during the course of the plastering operations.
2. For continuity purposes the test cubes are to be prepared at regular intervals in the presence of the Surveyor. A minimum of 6 test cubes are required.
3. The test cubes are to be cured in company with the full.
4. All test cubes are to be weighed prior to testing.
5. The compression tests are to be carried out as soon as possible after the completion of curing i.e. after the 28th day.
6. If possible a Surveyor should witness these tests.
7. A minimum crushing strength of at least 34.5 MPa must be obtained.

APPENDIX AC

SKEG OR SOLE PIECE SCANTLINGS TABLE

The scantlings of sole pieces are to be based on the rudder force (N)

$$N = K \times A \text{ tonnes}$$

Where A = area of rudder in square metres

K = value from following Table A

TABLE A

Speed knots	Length of Vessel (m)		
	10	20	
6	1.07	1.12	1.18
7	1.16	1.22	1.28
8	1.30	1.35	1.40
9	1.50	1.50	1.50
10	1.65	1.65	1.65
11	1.82	1.82	1.82
12	1.99	1.99	1.99

TABLE B

Rudder force (N) (tonnes)	Athwartship breadth x thickness (mm)					
	Distance from centre line of rudder to propeller post (m)					
	0.4m	0.6 m	0.8 m	1.0 m	1.2 m	1.4 m
0.9	80 x 30	100 x 35	105 x 35	115 x 40
1.2	90 x 30	105 x 35	115 x 40	120 x 45	130 x 45	..
1.5	100 x 35	115 x 40	120 x 45	130 x 45	140 x 50	150 x 50
1.8	105 x 35	120 x 40	130 x 45	140 x 50	150 x 50	165 x 55
2.1	110 x 40	120 x 45	135 x 45	145 x 50	155 x 55	165 x 55
2.4	115 x 40	130 x 45	140 x 50	150 x 55	165 x 55	170 x 60
3.0	120 x 45	140 x 45	150 x 55	160 x 55	175 x 60	185 x 60
4.5	140 x 45	160 x 55	175 x 60	190 x 65	200 x 70	215 x 70

Notes:

1. The sole piece sizes given are for vessels without rudder posts. Where rudder posts are fitted the scantlings of sole pieces will be specially considered.
2. A fabricated sole piece shall have the same modulus about both axes as a solid sole piece.